



Easy-to-clean,
smooth-wall interior

5,050 Gallon Upright Poly Tank

At Adler Tank Rentals, we are committed to providing safe and reliable containment solutions for all types of applications.

Made from cross-linked polyethylene for durability and safety, this 5,050 Gallon Upright Poly Tank can be used in many different applications for temporary liquid storage of chemicals, water, and other fluids. The tank is portable, lightweight and ideal for use in manufacturing, power plant projects, construction, environmental, and industrial applications where space is limited.

The 5,050 Upright Poly Tank has two molded 4-inch flanges with two 4-inch butterfly valves attached, located on the tank bottom for drainage and ease of cleaning. All Upright Poly Tanks come with a standard raised pad.

Capacity: 5,050 gallons
Combined Tank & Pad Weight: 2,515 lbs
Overall Height: 15'11¼"
Overall Width: 8'7"
Tank Weight: 2,200 lbs.
Pad Weight: 315 lbs.
Ladder Weight: 150 lbs.

All sizes are approximate.



Mechanical Features

- Material: High-density cross-linked polyethylene
- One-piece seamless molded construction
- IMFO Pad – Integrally Molded Flanged Outlet with 2" plug
- Six (6) Molded-in lifting lugs (top of tank)
- 22" Manway (top of tank)
- 4" Spare UBD fitting (top of tank)
- 8" PVC domed vent (top of tank)
- Two (2) 4" PVC Threaded drain valves (bottom of tank)
- Molded-in gallonage markers in 200-gallon increments
- Maximum Temperature: 100° F
- Maximum Specific Gravity: 1.90
- Certification: ASTM D1998 (NOT UL LISTED)

5,050 Gallon Upright Poly Tank

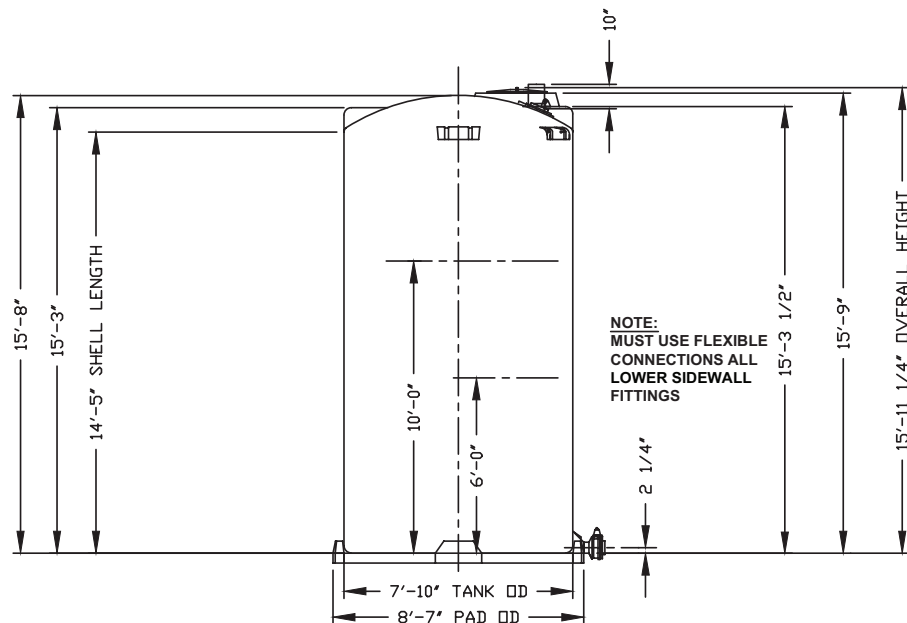
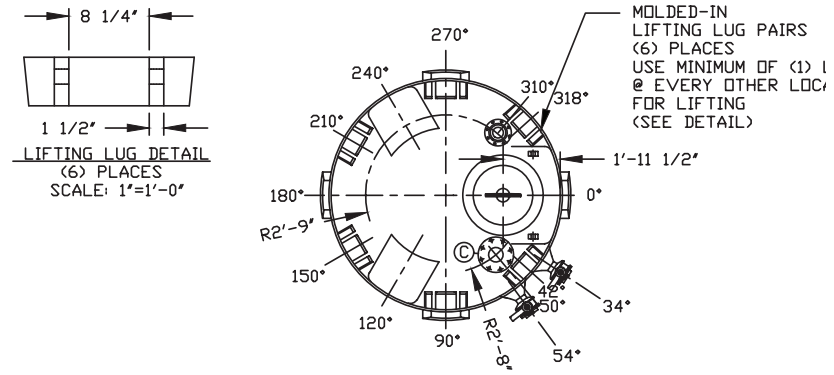

Safety Features

- Six (6) Molded-in lifting lugs (top of tank)
- High-visibility 13' aluminum with platform OSHA yellow ladder
- Strapping chart

Accessories

- Valves: Two (2) 4" butterfly valves w/FLG THRD PVC/SS/EDPM SS Ring
- Manway: Top mounted 22" opening (24" diameter screw-on cover)
- Top Vent: 8" mushroom vent assembly
- Top Spare: 4" UBD FTG flange style PVC/C-276/EDPM plug 4" pipe thread PVC 80

Comprehensive Service

Adler Tank Rentals provides containment solutions for hazardous and non-hazardous liquids and solids. We offer 24-hour emergency service, expert planning assistance, and transportation. All of our rental equipment is serviced by experienced Adler technicians and tested to exceed even the most stringent industry standards.

